

PLEASE! DO NOT RETURN THIS PRODUCT TO ANY RETAIL STORE!

For any questions or problems with this product please contact us at:

Email: info@interactivetoy.com

Phone: Inside North America: +1-416-444-6873

Outside North America: 1-866-214-2220

Address: Interactive Toy Concepts,
1192 Martin Grove Road, Toronto, Ontario, Canada. M9W 5M9

Web site: www.interactivetoy.com

REPLACING iFly DUCK HUNTER MAIN WINGS

You can replace the original wings on your iFly DUCK HUNTER if they become damaged. A new set of wings can be purchased by contacting Interactive Toy Concepts listed above. To replace the wings, do the following:

1. Make sure the Duck and the Shooter are turned off.
2. Gently remove the far corner of the wing that is tethered to the body by a ball joint.
3. The leading (front) edge of the wing is a thin carbon fiber rod. Gently pull this rod out of the gear box mechanism housing at the front.
4. Installation of the new wing is the reverse of the wing removal procedure with the following minor difference.
5. The carbon fiber rod has a slight notch cut into its end so that it will only fit properly into gear box mechanism housing one way. Use caution when inserting the carbon fiber rod. If it is not going in smoothly, it is misaligned.

IMPORTANT SAFETY INFORMATION

Do not modify your iFly DUCK HUNTER. Do not use in strong winds, use only in VERY mild conditions! Do not use in rain, snow or around heavy debris! Do not use near electrical lines! Do not use around smoke or flames! Do not use around water! Do not use around electricity! Do not use in crowded areas! Do not use around air conditioning! Do not use around air vents! Do not use around ceiling fans! Do not use around large obstacles! Do not use in very small spaces! Do be conscious of changes in your area! Any changes or modifications to this product are strictly prohibited and will void product warranty. Keep moving wings away from eyes, hands, hair and loose clothing. Always turn off your iFly DUCK HUNTER and Infra-red Shooter when not in use. Always remove batteries from Infra-red Shooter during storage. Always replace Infra-red Shooter with NEW alkaline batteries for optimal performance. Keep your instruction manual in a safe place for future use. Only use the provided Infra-red Shooter included with the iFly DUCK HUNTER to charge the lithium polymer battery installed in the iFly DUCK HUNTER.

Limited 30-day warranty

Product is warranted by Interactive Toy Concepts Limited against manufacturing defects in material and workmanship under normal use for (30) days from the date of purchase.

Warranty is validated upon receipt of proof of purchase and confirmation of UPC code.



Duck Hunter and iFly are registered trademarks of Interactive Toy Concepts.
© 2009. All Rights Reserved. Manufactured by and distributed by Interactive Toy Concepts Ltd.
Patent Information: EU: EP1958681 US: US2008191100 Canada: CA2607358 Aus: AU2007231617
Products and colors may vary. MADE IN CHINA.



INS-44028-022509-US

8+
Item# 44028

INSTRUCTION MANUAL

Congratulations on your purchase of the iFly DUCK HUNTER

The iFly DUCK HUNTER is a revolutionary new toy that allows anyone to have the virtual learning experience of hunting a Duck in complete safety.

The iFly DUCK HUNTER Shooter uses a narrow infra-red beam to shoot down a fully functional, flying "ornithopter" Duck. An ornithopter is a device that flies by flapping its wings. Thus, the ornithopter Duck's flying pattern is very life-like. The Duck will fly for 30-40 seconds from a 10 second charge. The body of the Duck is made of an ultra-light and flexible foam which provides excellent structure and resistance to damage. Since the flying direction of the Duck can be preset, it is possible to play with the iFly DUCK HUNTER indoors or outdoors. It takes 3 direct hits from the infra-red blaster to bring down the Duck. It is possible to have a competitive game-play with any number of multiple players or to practice solo target shooting accuracy.

A multiple player game-play consists of counting the number of shots fired to bring down the Duck. The person who fires the least amount of shots is the winner.

The iFly DUCK HUNTER has been carefully packaged to avoid damage during shipping.

PLEASE USE CAUTION WHEN UNPACKING.



1 iFly "DUCK HUNTER" Flying Duck



1 Infra-red Shooter/Portable Charger

IMPORTANT BATTERY INFORMATION:

Do not mix old and new batteries, different types of batteries, standard carbon zinc, alkaline or rechargeable of different capacities. Rechargeable batteries are only to be charged under adult supervision. Please respect the correct polarity (-) or (+). Do not try to recharge non-rechargeable batteries. Do not throw batteries into the fire. Replace all batteries of the same type/brand at the same time. The supply terminals are not to be short-circuited. Remove exhausted batteries from the toy. Batteries should be replaced by adults. Remove batteries if the toy is not going to be played with for some time. The packaging should be kept since it contains important information.



INSTALLING BATTERIES

The Duck has a built-in, non-removable, non-replaceable, rechargeable capacitor. The charger is built into the Shooter and requires 3 "AAA" alkaline batteries (sold separately). Use only the supplied charger provided in this iFly DUCK HUNTER package to charge the Duck. **DO NOT USE ANY OTHER SOURCE TO CHARGE THE DUCK.** Install the batteries as shown.

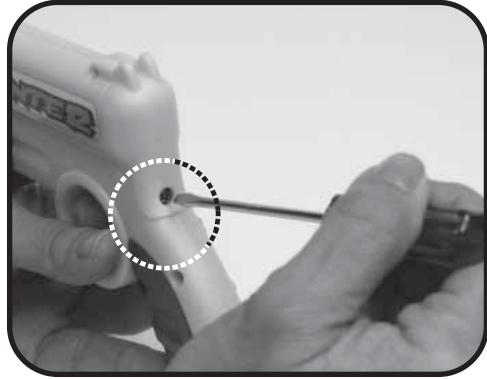

1. Open the battery compartment door located at the upper rear of the Shooter by using a Philips screwdriver (not included).

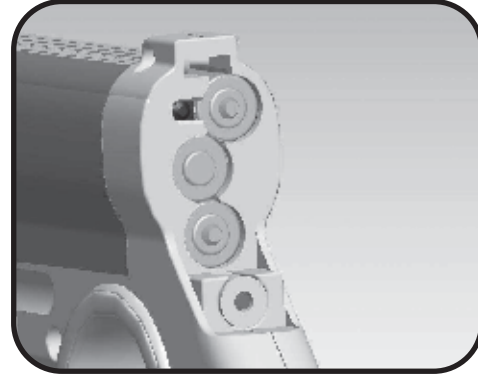

2. Insert the 3 AAA batteries according to the picture (shown). Ensure that the + and - polarities match the illustrations inside the battery compartment.

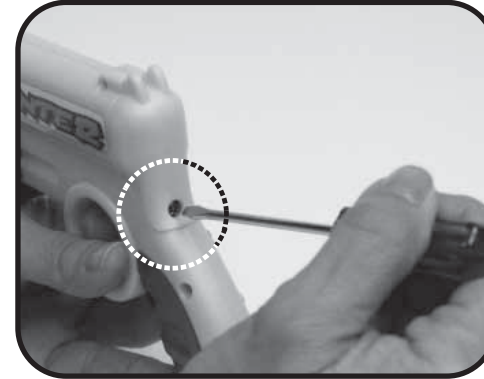

3. Replace the battery compartment door and tighten the screw using the screwdriver. Do not over tighten.

CHARGING THE ifly DUCK HUNTER

The Duck requires 10 seconds of charging time for a flight-time of 30 to 40 seconds. Charging the Duck is a simple process as outlined in the following steps.

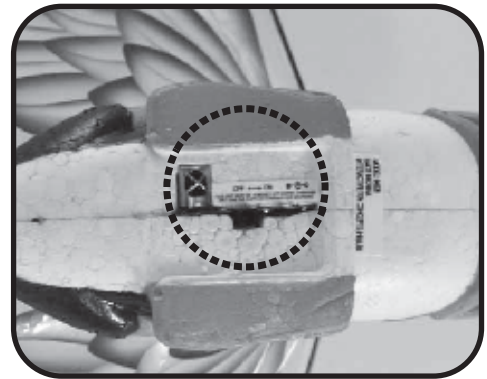

1. Turn the Duck's ON/OFF switch to the OFF position for charging.

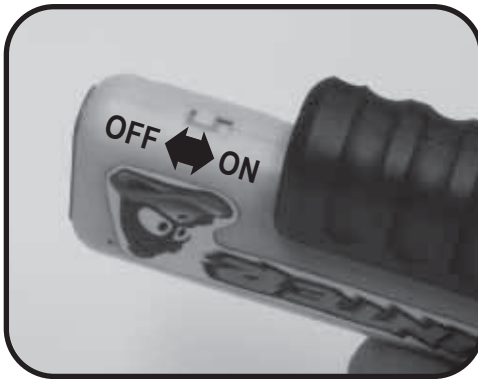

2. Turn the Shooter's ON/OFF switch to the ON position for charging.

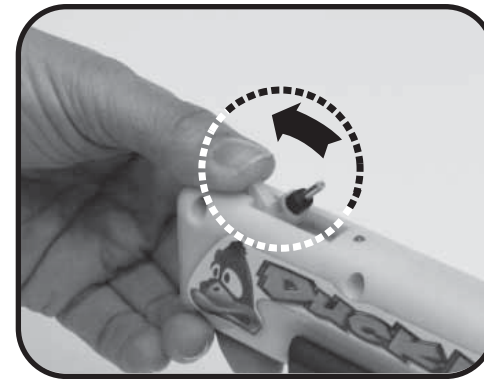

3. Lift the charge-rod located at the top front of the Shooter to the up position.

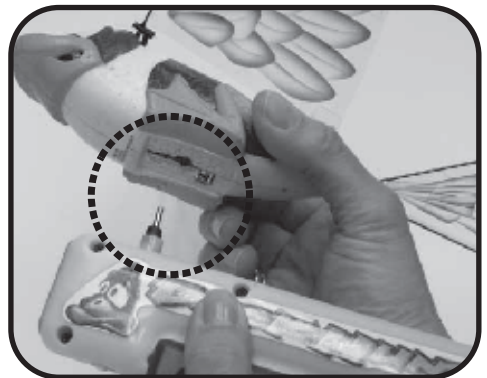

4. Locate the charge hole on the bottom side of the Duck and insert the Shooter's charge rod completely. The Duck will sit on the Shooter snugly.

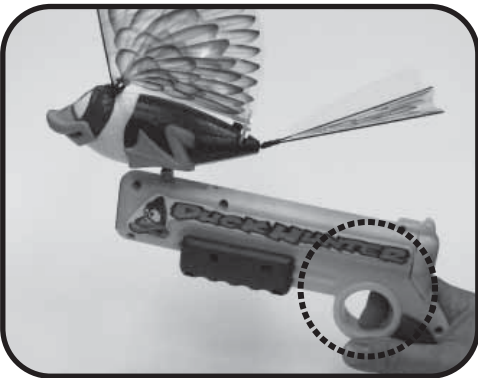

5. Press and hold the charge button located in the trigger area of the Shooter for about 10 seconds.

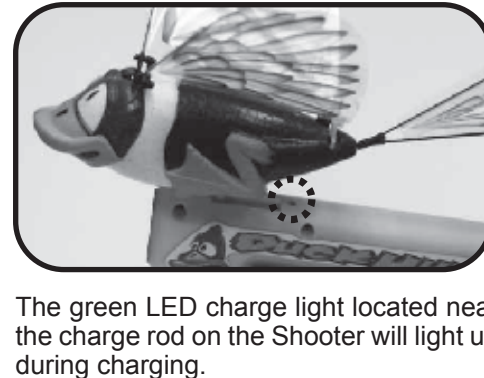

The green LED charge light located near the charge rod on the Shooter will light up during charging.

6. Release the charge button after 10 seconds of charging the Duck. The green LED charge light will turn off. Remove the Duck from the charge rod on the Shooter.

WARNING! DO NOT CHARGE FOR LONGER THAN 10 SECONDS. DAMAGE MAY OCCUR TO THE CAPACITOR INSIDE THE ifly DUCK HUNTER.

7. The Duck is now ready to fly. The charge is maintained until the ON/OFF switch on the Duck is set to the ON position. This handy feature allows you to fly your Duck when YOU are ready!



8. Leave the Shooter's ON/OFF switch in the ON position after charging the Duck. Press the charge rod down on the Shooter after charging. In the down position, the charge rod is an integral part of the target sighting system.

CHOOSING YOUR FLYING LOCATION

Do not fly your Duck during windy conditions or harsh weather. You can operate your iFly DUCK HUNTER toy indoors or outdoors. The outdoor space should be roughly 32' x 32' (10m x 10m) with a height allowance of about 19' (6m). Avoid

operating your iFly DUCK HUNTER near power-lines, trees, or roof-tops. If flying your Duck indoors, the area should be roughly 16' x 16' (5m x 5m) and the standard household ceiling height.

FLYING AND HUNTING YOUR IFLY DUCK HUNTER

The Duck is ready to fly as soon as it is finished charging. The objective of the iFly DUCK HUNTER game using single or multiple player mode is to shoot down the Duck with the Shooter within its 30 to 40 second flight time window. It takes 3 direct hits to bring down the Duck.

1. When you are ready to fly your fully charged Duck you should first adjust the "direction of flight" setting to the fly pattern of your choice. This is done by pivoting the directional control tab to the left, center, or to the right. The directional control tab is located at the dorsal (upper) rear end of the Duck's body and has the two main wings attached to it. By pivoting the directional control tab to the left, the Duck will fly to the left and by pivoting the directional control tab to the right, the Duck will fly to the right. When the directional control tab is positioned in the center, the Duck will fly straight. The farther the directional control tab is pivoted towards a certain side, the more the Duck will bank towards that direction during its flight.



DIRECTIONAL CONTROL TAB



DIRECTIONAL CONTROL TAB

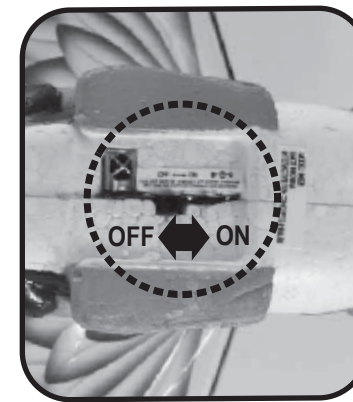

2. Move the duck's ON/OFF switch to the ON position. The wings will start to flap.



3. Gently toss the Duck into the air. It will fly for about 30 to 40 seconds.

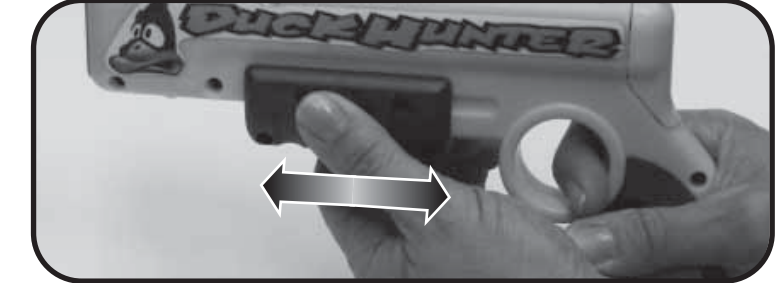

4. To fire at the Duck, it is necessary to reload the Shooter. Reloading the Shooter is done by sliding the pump all the way backwards and forwards. A reloading sound is heard if this process is done successfully. Note: it is necessary to reload the Shooter after each shot fired. Once the Shooter is reloaded, you can fire a narrow infra-red beam at the Duck by pressing the trigger button on the Shooter. A firing sound is heard.

- If your shot misses the Duck, the Duck will continue to fly in its pre-determined path.
- If your shot hits the Duck, it will stop operating for a brief moment and appear to fall. This is meant to simulate a glancing blow to the Duck. The Duck will resume its flight right away.
- Reload the Shooter and shoot at the duck again.
- When you shoot the Duck directly for the second time, the Duck will appear to temporarily fall again. Normal flight will resume again momentarily.
- Reload the Shooter and shoot at the Duck again.
- When you shoot the Duck directly for the third time, it will fall from the sky.

Congratulations on your marksmanship!

- If you are unable to hit the Duck three times with the narrow infra-red beam of your Shooter the Duck will land on the ground naturally.

5. When Duck has been shot down or has landed on its own, turn it OFF to recharge it before playing again. Turning the Duck OFF resets the system. It is not necessary to turn the Shooter OFF before recharging the Duck. To recharge the Duck, follow the steps outlined under "Charging the iFly DUCK HUNTER".

6. If you are finished playing, make sure to turn the ON/OFF switches on the Duck and on the Shooter the OFF position for storing. It is best to remove the batteries from the Shooter if it will be stored for a longer period of time.